

# Assembly Instructions

## Challenge Mat: Ultimate Soccer

### Unroll the soccer mat

#### Defenders

1. Punch the defenders out from their respective boards.
2. Clip one plastic stand on the bottom of each defender and arrange on the mat as desired.

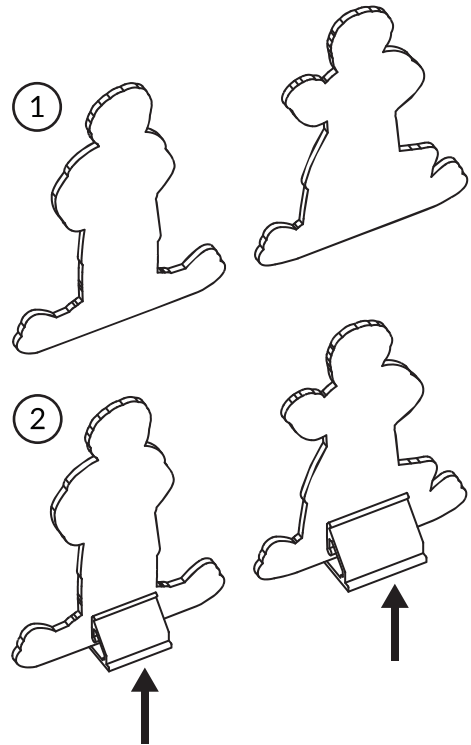

#### Goals

1. Punch the goal pieces out from their respective boards.
2. Insert the tabs from the triangular side pieces into the slots on the larger rectangular upper part of the goal.
3. Insert the tabs from the side walls of the goal into the small rectangular back part of the goal.
4. Assemble the second goal.
5. Insert the lower front tabs of the side walls into the slots cut into the neoprene at the goalie box. Note: Both goals should be locked in place and facing each other from opposite sides of the pitch.

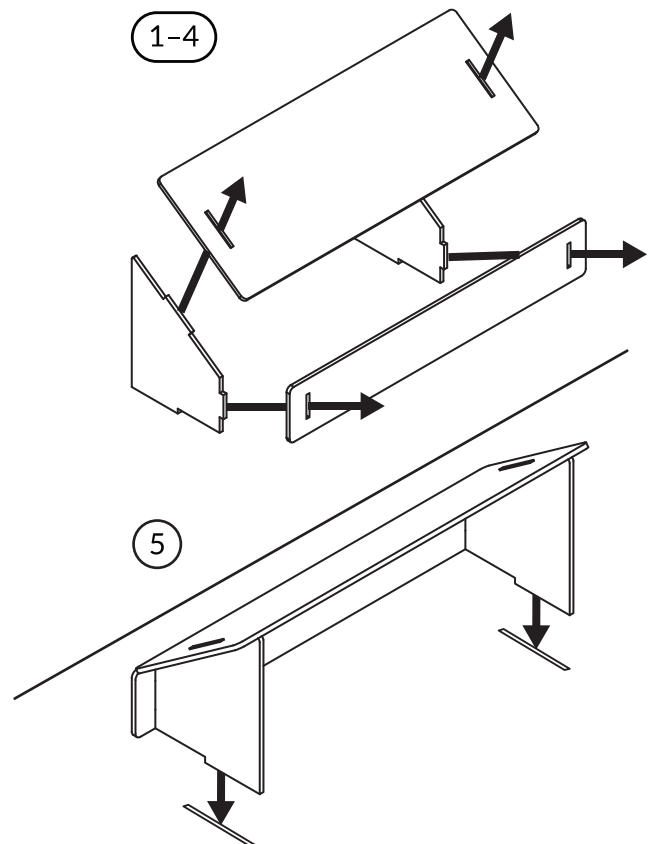

# Assembly Instructions

## Challenge Mat: Ultimate Soccer

### Legs

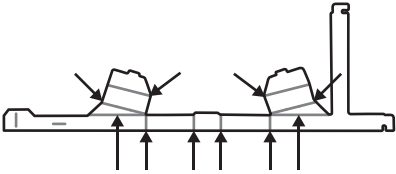
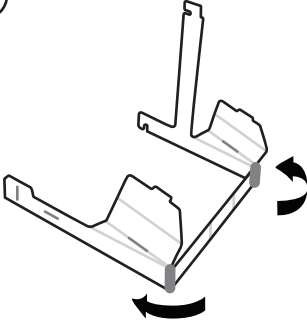
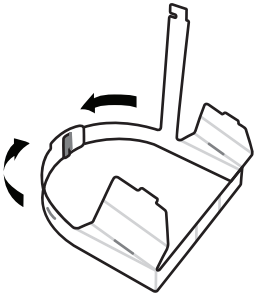
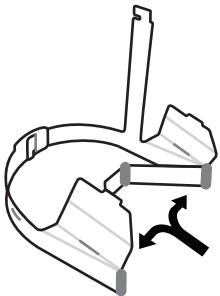
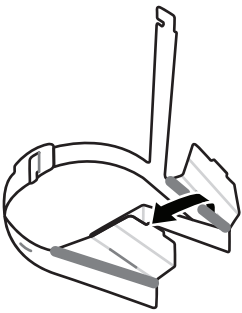
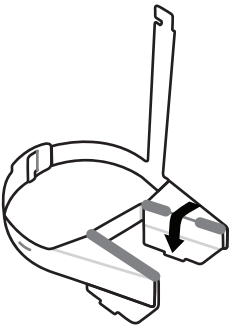
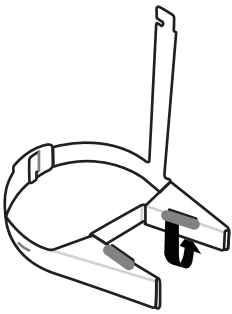
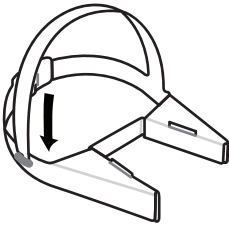
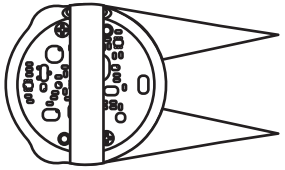
<p>①</p>  <p>Begin by making a hard crease along the indicated folds.</p>	<p>②</p>  <p>Bend the front two points to 90 degrees.</p>	<p>③</p>  <p>Hook the two ends of the back belt together.</p>
<p>④</p>  <p>Bend the middle portion of the front inwards.</p>	<p>⑤</p>  <p>Fold over the top covers of the forks.</p>	<p>⑥</p>  <p>Fold the flaps over the inner portion of the forks.</p>
<p>⑦</p>  <p>Double the flap over the inner fork and tuck the tab in through the slot to hold it in place.</p>	<p>⑧</p>  <p>Hook the top strap into the corresponding slit on the other side of the main belt.</p>	<p>⑨</p>  <p>Place on top of Evo with the pointed ends facing forward. Check that the forks do not drag across the surface while moving. Note: The clear adhesive dots can be used to secure the legs to Evo if needed.</p>